

VERKTØYKAMPANJE

Gyldig ut juli 2025



BAHCO



SNA Europe is a *Snap-on* Group company

LINDSTRÖM®



DIN VERKTØYPARTNER!

SNA Europe (Norway) AS er et solid selskap som markedsfører og selger et bredt utvalg av håndverktøy, tilbehør og oppbevaring under varemerkene Bahco®, IRIMO®, Lindström® og Norbar®.

En nøkkel-flere muligheter Kjøp innstikk etter behov



175,-
eks mva

RINGNØKKEL TOMMER
9X12, Max 105Nm
Art kode 98-1/2



175,-
eks mva

METRISK RINGNØKKEL
9X12, Max 25Nm
Art kode 98-7



216,-
eks mva

METRISK U-NØKKEL
9X12, Max 51Nm
Art kode 97-13



916,-
eks mva

RUNDT
SKRALLEHODE
9X12, Max 160m
Art kode 9T-1/2



74W9/74W14



517,-
eks mva

RUNDT
SKRALLEHODE
9X12, Max 160m
Art kode 9R-1/2

Ved bruk av forlenger eller adapter vil verdien for utgangsmomentet endres og det må regnes ut nytt utgangsmoment for nøkkelen.



BAHCO



233,-
eks mva

ÅPEN RINGNØKKEL TOMMER
9X12, Max 28Nm
Art kode 99-1/2



362,-
eks mva

ADAPTER FOR
PÅSVEISING
9X12
Art kode 9W

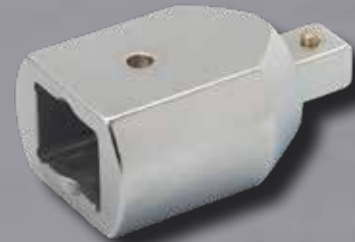

ADAPTER
9X12, 14X18
Art kode 9A-14

507,-
eks mva

ADAPTER
14X18, 9x12
Art kode 14A-9

624,-
eks mva

ADAPTER
24x32, 14X18
Art kode 24A-14

968,-
eks mva

ADAPTER
14X18, 24x32
Art kode 14A-32

897,-
eks mva

ADAPTER
27x36, 24x32
Art kode 27A-24

1.815,-
eks mva

ADAPTER
24x32, 27x36
Art kode 24A-27

1.535,-
eks mva

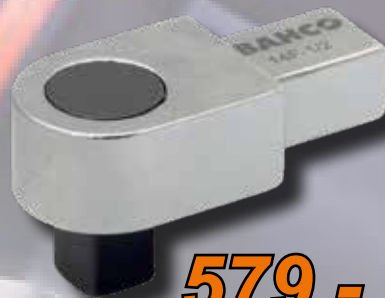

579,-
eks mva

FAST INNSATS
9X12, Max 30m
Art kode 9F-1/2



747,-
eks mva

PÆREFORMET
SKRALLEHODE
9X12, Max 30m
Art kode 9Q-1/2



MEKANISK JUSTERBAR KLIKKMOMENTNØKSEL MED UTSKIFTBART HODE

- Slitesterk mekanisme med over 100 000 sykluser innenfor toleransene
- Kan brukes med eller mot klokken ved å snu nøkkelen
- Klikksystemet utløser et følbart og et hørbart signal
- Nøyaktighet $\pm 3\%$ av avlesningen, som overgår kravene i ISO 6789-1:2017

Art kode	Nm	Innstikk	Pris
74W9-15	3-15	9x12mm	2.182,-
74W9-25	5-25	9x12mm	2.168,-
74W9-50	10-50	9x12mm	1.932,-
74W9-100	20-100	9x12mm	2.060,-
74W9-200	40-200	9x12mm	2.608,-
74W14-200	40-200	14x18mm	2.554,-
74W14-300	60-300	14x18mm	3.475,-
74W14-400	80-400	14x18mm	3.885,-



DIGITAL MOMENT- OG VINKEL BLUETOOTH NØKSEL M/UTSKIFTBART HODE

- Bluetooth® sanntids 2-veis dataoverføring
- Bahco Connect gratis app tilgjengelig på 18 språk
- Minnekapasitet på 1500 avlesninger og opptil 50 forhåndsinnstillinger



Art kode	Nm	Innstikk	Pris
TAWMB14340	17-340	14X18mm	11.786,-
TAWMB24650	32.5-650	24x32mm	15.242,-
TAWMB24800	40-800	24x32mm	16.813,-

DIGITAL SLANK MOMENT- OG VINKEL BLUETOOTH NØKSEL M/MINNE OG UTSKIFTBART HODE

- Bluetooth® sanntids 2-veis dataoverføring
- Bahco Connect gratis app tilgjengelig på 18 språk
- Minnekapasitet på 1500 avlesninger og opptil 50 forhåndsinnstillinger

Art kode	Nm	Innstikk	Pris
TAWMB930M	1.5-30	9x12mm	12.256,-
TAWMB9135M	7-135	9X12mm	13.042,-



ELEKTRONISK VINKELMÅLER MED MAGNET

- 9 Forhåndsinnstillinger
- Visuelt og hørbart signal
- Kan brukes med og mot klokken

1.492,-
eks mva

Art kode MAM50M

Er det lenge siden du kontrollerte momentnøkkelen din? Gjør det enkelt selv!



13.500,-
eks mva

MULTIFUNKSJONSTESTER FOR MOMENTSKRUTREKKERE OG MOMENTNØKLER

- Kontroll av momentnøkler på bla verksteder
- Brukes med klokken i temperaturer fra -10°C til $+50^{\circ}\text{C}$
- Opptil 10 målmomentinnstillinger og respektive tåleranser

Art kode			Pris
TEA003	1/4"	0.1-3.0 Nm	12.570,-
TEA010	1/4"	0.5-10 Nm	11.786,-
TEA030A	10 mm	1.5-30 Nm	10.213,-

MULTIFUNKSJONSTESTER FOR MOMENTSKRUTREKKERE OG MOMENTNØKLER

- Kontroll av momentnøkler på bla verksteder
- Brukes med klokken i temperaturer fra -10°C til $+50^{\circ}\text{C}$
- Opptil 10 målmomentinnstillinger og respektive tåleranser

Art kode			
TEA065	3/8"	3-65 Nm	



PREMIUM HYDRAULISK FLASKEJEKK

- For arbeide i vertikal og horisontal posisjon
- Sveiset struktur forhindrer oljelekkasje
- Driftsforhold: -20°C til 50°C

Art kode	Løftekap.	min høyde	max høyde	Pris
BH4B2	2000 kg	178mm	347mm	663,-
BH4B5	5000 kg	198mm	390mm	768,-
BH4B8	8000 kg	198mm	392mm	1.198,-
BH4B12	12000 kg	240mm	468mm	1.524,-
BH4B20	20000 kg	270mm	430mm	1.791,-
BH4B30	30000 kg	280mm	445mm	2.316,-

HYDRAULISK FLASKEJEKK

- For arbeide i vertikal og horisontal posisjon
- Sveiset struktur forhindrer oljelekkasje
- Driftsforhold: -20°C til 50°C



Art kode	Løftekap.	min høyde	max høyde	Pris
BH4G2	2000 kg	181mm	344mm	306,-
BH4G4	4000 kg	193mm	373mm	374,-
BH4G6	6000 kg	210mm	416mm	447,-
BH4G8	8000 kg	230mm	460mm	556,-
BH4G12	12000 kg	230mm	440mm	691,-
BH4G20	20000 kg	242mm	452mm	934,-
BH4G50	50000 kg	265mm	425mm	2.293,-

KOMPAKT LUFTHYDRAULISK JEKK 30/15T

- Robust design for lang levetid
- To høydeadaptere på 45 og 75 mm medfølger
- Sikkerhetsventil forhindrer overbelastning
- Veier kun 33 kg

10.706,-
eks mva



Art kode	Løftekap.kg	BAR	min høyde	max høyde
BH23015C	3000	8-12	150	292mm



LUFTHYDRAULISK JEKK 30/15T

- Robust design for lang levetid
- To høydeadaptere på 45 og 75 mm medfølger
- Sikkerhetsventil forhindrer overbelastning
- 54,5 kg

17.500,-
eks mva



PERFEKT FOR SERVICE LANGS VEII

6.357,-
eks mva

LUFTHYDRAULISK JEKK 50T

- Perfekt løsning for bergingsbiler
- Designet for intensiv og tung bruk
- Sveiset struktur hindrer oljelekkasje
- Driftstemperatur: -20°-70°C



Art kode	Løftekap.kg	BAR	min høyde	max høyde
BH4HP50	50000	6,89-8,27	300mm	470mm

Art kode	Løftekap.kg	BAR	min høyde	max høyde
BH23015	3000	8-12	150	289mm



BUKK (PAR) 3 & 6 T

- Faste ” klikk posisjoner
- Ekstra store føtter gir økt stabilitet
- Låsesystem med sikkerhetssplint



Art kode	Løftekap.	min høyde	maks høyde	Pris
BH33000	3000kg	330mm	435mm	591,-
BH36000	6000kg	400mm	620mm	1.083,-



SELVLØFTENDE BUKK (PAR) 3,5 & 10T

- Automatisk løftesystem
- Kan brukes med en hånd
- Låsesystem med sikkerhetssplint



Art kode	Løftekap.	min høyde	maks høyde	Pris
BH3A3000	3000kg	340mm	510mm	933,-
BH3A5000	5000kg	400mm	620mm	1.244,-
BH3A10000	10000kg	505mm	770mm	2.486,-

ALUMINIUMS BUKK (PAR) 2,5T

- Perfekt til veihjelp, kun 2,2 kg pr stk
- Forsterket aluminiumsbunn
- Gjennomgående sikkerhetssplint



1.376,-
eks mva

PERFEKT FOR
SERVICE LANGS VEI!

Art kode	Løftekap.	min høyde	maks høyde
BH3AL2500	2500kg	269mm	390mm

EKSTRA KRAFTIG BUKK 12T

- Kulelagersystem for nøyaktig høydejustering
 - Spesiell rund løftesadel i gummi
 - Selges enkeltvis
- Reservedel: Gummisadel BH3HD12000-01



Art kode	Løftekap.	min høyde	maks høyde	Pris
BH3HD12000	12000kg	350mm	510mm	1.345,-
BH3HD12000-01				93,-

EKSTRA KRAFTIG BUKK 8T

- Kulelagersystem for nøyaktig høydejustering
- Spesiell rund løftesadel i gummi
- Selges enkeltvis

Reservedel: Gummisadel BH3HD8000-01

Art kode	Løftekap.	min høyde	maks høyde	Pris
BH3HD8000	8000kg	385mm	600mm	691,-
BH3HD8000-01				85,-



EKSTRA KRAFTIG BUKK 16T

- Sikkerhetssplint med gummigrep
- Spesiell rund løftesadel i gummi
- Selges enkeltvis

Reservedel: Gummisadel BH3HD12000-01

Art kode	Løftekap.	min høyde	maks høyde	Pris
BH3HD16000	16000kg	475mm	715mm	1.600,-
BH3HD12000-01				93,-



BUKK MED FIRKANTET BASE 7T

- Bred for for bedre trykkfordeling
- Sikkerhetssplint med gummigrep
- Selges enkeltvis

829,-
eks mva



Art kode	Løftekap.	min høyde	maks høyde	Pris
BH3SQ7000	7000kg	268mm	420mm	

**BAHCO****15.400,-**
eks mva

FOR TUNGE JORDBRUKSMASKINER M.M

HJULLØFTER 1,5T

- For enkel montering & demontering av hjul
- Hjul med bremsesystem
- Maksimal lastekapasitet: 1500kg
- Åtte kraftige ruller med kulelagere

Art kode
BH8AC3-1500A**REPARASJONSSETT FOR OLJEPLUGGER**

- For rask reparasjon av oljeplugger
- Passer de fleste bilprodusenter
- Leveres i plastboks

Art kode	Pris
BOD101 / M13 x 1.25P tapp + 6 skruer + 12 kobberskiver	348,-
BOD102 / M13 x 1.5P tapp + 6 skruer + 12 kobberskiver	334,-
BOD103 / M15 x 1.5P tapp + 6 skruer + 12 kobberskiver	334,-
BOD104 / M17 x 1.5P tapp + 6 skruer + 12 kobberskiver	384,-
BOD105 / M20 x 1.5P tapp + 6 skruer + 12 kobberskiver	396,-
BOD106 / M22 x 1.5P tapp + 6 skruer + 12 kobberskiver	513,-

**1.216,-**
eks mva**BÅNDSLIPER 10MM**

- Båndstørrelse 10x330 mm
- Ideell for arbeid på trange steder
- Luftutslipp i håndtaket

Art kode	BAR	Innfestn.	omdr/min	dBA
BP212	6.3	1/4	16000	83

BÅNDSLIPER 20MM

- Båndstørrelse 20x520mm
- Ideell for arbeid på trange steder
- Luftutslipp i håndtaket

**1.645,-**
eks mva

Art kode	BAR	Innfestn.	omdr/min	dBA
BP222	6.3	1/4	16000	85,5

Art kode	BAR	Innfestn.	omdr/min	dBA
BP823	6.3	1/4	10000	83

**153,-**
eks mva**OLJETRAKT**

- For tapping av olje til små beholdere
- Tåler de vanligst brukte bilproduktene, med unntak av bremsevæske
- Traktens diameter er 165mm
- Fleksibel slange i PVC
- Slangelengde: 400 mm og 16mm i diameter

Art kode
BOD301200**VINKELSLIPER 5"**

- For sliping og skjæring
- Lett, holdbart og isolert hus i komposittmateriale
- Verktøyfri mekanisme for skivebytte

2.835,-
eks mva**SAMMENFELLBAR VERKSTEDKRAN, 600KG**

- For løfting av girkasser, motorer etc
- 3 faste stillinger: 600,400 & 200 kg
- Min.inngangshøyde: 100mm
- Maks.krokhøyde: 2135mm
- Sammenfellbare ben

7.713,-
eks mvaArt kode
BH6PC600

PERFEKT TIL LASTING OG AVLASTING AV DELER DIREKTE PÅ EN EUROPALLI



1/4" PIPESETT
 • 20 deler
 • Høykvalitets stål
 • Høyglanspolert



Art kode
 6715MG

1.977,-
 eks mva



1/4" PIPESETT
 • 29 deler
 • Høykvalitets stål
 • Høyglanspolert



Art kode
 6715PZ

2.341,-
 eks mva

1/4" PIPESETT
 • 16 deler
 • Høykvalitets stål
 • Høyglanspolert

1.544,-
 eks mva



Art kode
 6715MGS



1/4" PIPESETT
 • 33 deler
 • Høykvalitets stål
 • Høyglanspolert



Art kode
 6720NM



3.650,-
 eks mva



3/8" PIPESETT
 • 22 deler
 • Høykvalitets stål
 • Høyglanspolert



Art kode
 7422MHR

2.507,-
 eks mva



1/2" PIPESETT
 • 25 deler
 • Høykvalitets stål
 • Høyglanspolert



Art kode
 7888DM

3.354,-
 eks mva

3/8" PIPESETT
 • 22 deler
 • Høykvalitets stål
 • Høyglanspolert

3.556,-
 eks mva



Art kode
 A7435DME



1/4" & 1/2" PIPESETT
 • 42 deler
 • Høykvalitets stål
 • Mattforkrommet overflate



Art kode
 7842MH

2.832,-
 eks mva



3/4" PIPESETT
 • 21 deler
 • Høykvalitets stål
 • Metallkoffert



Art kode
 8821MB

9.960,-
 eks mva



3/4" PIPESETT
 • 24 deler
 • Høykvalitets stål
 • Metallkoffert



Art kode
 8840M

10.180,-
 eks mva





MUTTERAVTREKKERPIPER

- 7 deler
- For fjerning av ødelagte muttere og skruer, spesielt låsemuttere
- Inneholder: 6 piper og en dor



Art kode
BWTSP7

1.492,-
eks mva



MUTTERAVTREKKERPIPER

- 16 deler
- For fjerning av ødelagte muttere og skruer, spesielt låsemuttere
- Inneholder: 14 piper, et adapter og en dor

1.650,-
eks mva

Art kode
BWTSP16



BAHCO

”PROBLEMLØSEREN”

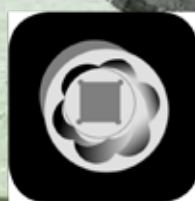

For fjerning av ødelagte muttere og skruer, spesielt låsemuttere

1/2" KRAFTPIPESETT

- 14 deler
- Høykvalitets stål
- Fosfatert utførelse



791,-
eks mva

Art kode
D/S14



1/2" KRAFTPIPESETT

- 10 deler
- Høykvalitets stål
- Fosfatert utførelse



809,-
eks mva

Art kode
DD/S10



1/2" KRAFTPIPESETT

- 10 deler
- Høykvalitets stål
- Fosfatert utførelse



579,-
eks mva

Art kode
D/S10



1/2" KRAFTPIPESETT

- 14 deler
- Høykvalitets stål
- Fosfatert utførelse



1.312,-
eks mva

Art kode
DD/S14

1/2" KRAFTPIPESETT

- 20 deler
- Høykvalitets stål
- Fosfatert utførelse



1.278,-
eks mva

Art kode
D-DD/S20





BAHCO



1/4", 3/8" & 1/2" PIPESETT
 • 138 deler
 • Høykvalitets stål
 • Inneholder også kombinasjonsnøkler, kråkefotnøkler og skrutrekkerbits

Art kode
S138

2.349,-
eks mva



1/4", 3/8" PIPESETT
 • 33 deler
 • Høykvalitets stål
 • Matt overflate

920,-
eks mva

Art kode
S330L



GJENNOMGÅENDE PIPESETT
 • 53 deler
 • Høykvalitets stål
 • Matt overflate



1.249,-
eks mva

Art kode
S530T



1/4" & 1/2" PIPESETT
 • 56 deler
 • Høykvalitets stål
 • Matt overflate



1.102,-
eks mva

Art kode
S560



1/4" PIPESETT, LANGE & KORTE PIPER
 • 37 deler
 • Høykvalitets stål
 • Matt overflate



445,-
eks mva

Art kode
SL25L



1/2" PIPESETT M/ KOMBINASJONSNKL, BITS, HAMMER, TANG
 • 71 deler
 • Høykvalitets stål
 • Matt overflate



1.705,-
eks mva

Art kode
S71MIX



1/4" PIPESETT
 • 25 deler
 • Høykvalitets stål
 • Matt overflate



325,-
eks mva

Art kode
SL24

3/4" PIPESETT
 • 20 deler
 • Høykvalitets stål
 • Matt overflate



2.870,-
eks mva

Art kode
SLX20



1/4" PIPESETT
 • 65 deler
 • Høykvalitets stål
 • Matt overflate
 • Slank skralle



816,-
eks mva

Art kode
SL65





1.298,-
eks mva



- 3/4" KRAFTPIPESETT**
- 8 deler
 - Høykvalitets krom-molybden stål
 - Fosfatert utførelse

Art kode
173-01-5



1.139,-
eks mva



- 1" KRAFTPIPESETT**
- 7 deler
 - Høykvalitets krom-molybden stål
 - Fosfatert utførelse

Art kode
177-10-5

- 1/2" KRAFTPIPESETT**
- 14 deler
 - Høykvalitets krom-molybden stål
 - Fosfatert utførelse



839,-
eks mva



Art kode
168-14-4

- 1/2" & 1/4" PIPESETT**
- 103 deler
 - Forkrommet og polert overflate
 - Plastkoffert med metallspenner

Art kode
129A-103-4



1.379,-
eks mva



1.959,-
eks mva

- 1/4", 3/8" & 1/2" PIPESETT**
- 172 deler
 - Forkrommet og polert overflate
 - Plastkoffert med metallspenner



Art kode
129-172-4



315,-
eks mva

- 1/4" PIPE- & BITSSETT**
- 37 deler
 - Blankforkrommet overflate
 - Håndtak av to-komponents materiale



Art kode
109-37-4



2.210,-
eks mva

- 3/4" PIPESETT**
- 21 deler
 - Forkrommet polert overflate
 - Plastkoffert med metallspenner



Art kode
139-21B-4



- 1/2" PIPESETT**
- 12 deler
 - Forkrommet polert overflate
 - På festeskinne

Art kode
129-12-4

344,-
eks mva



- 1/4" PIPESETT**
- 13 deler
 - Forkrommet polert overflate
 - På festeskinne



Art kode
109-13-4

180,-
eks mva



3.960,-
eks mva

**KOMBINASJONSNØKKESETT
METRISK**
• 24 deler
• Høykvalitets stål
• Bedre tilgjengelighet
med 15° kjeftvinkel



Art kode
111M/24T

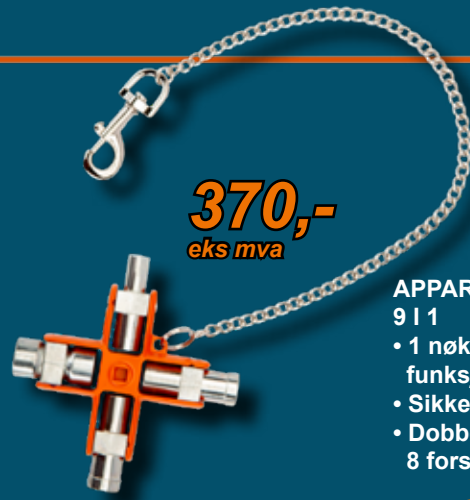

370,-
eks mva



**APPARATSKAPSNØKLER
9 I 1**

- 1 nøkkel med 9 forskjellige funksjoner
- Sikkerhetskjede med krok
- Dobbel vrimekanisme for 8 forskjellige posisjoner

Art kode
MK9

ERGONOMISK SKIFTENØKKE

- Vendbar kjeft
- Slanke kjefter
- Høykvalitets stål smidd i et stykke



*Vendbar kjeft-
kan også brukes som
rørtang!*

Art kode	Str	Pris
9070P	6"	270,-
9071P	8"	292,-
9072P	10"	380,-
9073p	12"	559,-

STILLAS SKIFTENØKKE

- Perfekt til heving av stålbjelker, stillaser og linjering av øyebolter
- Ideell for offshore olje-og gassindustrien
- Høykvalitets stållegering smidd i et stykke

*Jobb trygt
i høyden!*

397,-
eks mva

Art kode
TAH84-PODGER



SKRALLE-KOMBINASJONSNØKKESETT
• Skrallenøkler 10,13 & 19
• Adaptere for 1/4", 3/8" og 1/2" piper
• Adaptere for 1/4" & 5/16" bits med låsering

1.189,-
eks mva

Art kode
1RMA/S8



8-11, 12-15,
16-19 mm

566,-
eks mva

**RINGSKRALLENØKKESETT,
3 NØKLER**
• 4 Størrelser i samme nøkkel
• Enkel retningsendring
• Høykvalitets stål og Dynamic drive profil

Art kode
S4RM/3T



Hver nøkkel har 4 dimensjoner



8-11, 12-15,
16-19, 21-27
30-36 mm

2.091,-
eks mva



1.218,-
eks mva

**RINGSKRALLENØKKESETT
4 NØKLER**
• 4 Størrelser i samme nøkkel
• Enkel retningsendring
• Høykvalitets stål og Dynamic drive profil

Art kode
S4RM/4T

8-11, 12-15,
16-19, 21-27 mm

**RINGSKRALLENØKKESETT
5 NØKLER**
• 4 Størrelser i samme nøkkel
• Enkel retningsendring
• Høykvalitets stål og Dynamic drive profil

Art kode
S4RM/5T



BAHCO

ERGO TANGSETT 4 STK

- Vannpumpetang, Kombinasjonstang, Sideavbiter og spisstang
- Høykvalitets stål
- Rustbeskyttet

1.023,-
eks mva



Art kode
9897

SPORRINGSTANGSETT 4 STK

- For innvendige og utvendige sporringer
- 180 mm, 19 mm-60 mm

Art kode
28-29/S4

1.214,-
eks mva



**KOMPAKT AVBITER OG TANGSETT
3 STK**

- Sideavbiter, spisstang & mekanisk tang
- Høykvalitets stål
- Rustbeskyttet

1.485,-
eks mva



Art kode
C3902/3



SELVJUSTERENDE KRYMPETANG

- Kompakt design for enkel tilgang
- Ergonomisk håndtak
- Utløsermekanisme med sperremekanisme

3.219,-
eks mva



Art kode
CR SA H16



**SELVJUSTERENDE KRYMPETANG
TRAPESFORMET PROFIL**

- Kompakt design for enkel tilgang
- Ergonomisk håndtak
- Utløsermekanisme med sperremekanisme

Art kode
CR SA T01



346,-
eks mva

AUTOMATISK AVISOLERINGSTANG

- For alle typer kabler med tverrsnitt fra 0,2 mm² til 6 mm²
- Integreert, lett tilgjengelig sideavbiter opptil Ø2 mm
- Tangen justeres automatisk til lederens tverrsnitt

Art kode
3416A



BAHCO
3416A



ROTERENDE AVMANTLINGSVERKTØY

- For runde kabler med diameter mellom 4,5 og 28,5 mm
- Bladet kan justeres til forskjellige isoleringer opp til 3 mm tykkelse
- Ved trykk på knappen roterer bladet 90° og gir et langsgående snit

Art kode
3520A



327,-
eks mva



299,-
eks mva

**AVISOLERINGSTANG M/ ERGONOMISK
SKLISIKKERT HÅNDTAK**

- Avisoleringskapasitet: 6 mm til 13 mm
- Fluktende avisolering, også i vanskelig tilgjengelige områder
- Ikke nødvendig å justere skjæredybden

Art kode
3517A





BØYD ERGO SPISSTANG 60 °

- ESD sikre to-komponents håndtak
- Høykvalitets stållegering
- Induksjonsherdede kjefter med hardhet 42-46 HRC



Art kode
RX7892

464,-
eks mva



367,-
eks mva



BØYD SPISSTANG 60 °

- ESD sikre håndtak
- Høykvalitets stållegering
- Induksjonsherdede kjefter med hardhet 42-46 HRC

Art kode
7892

SIDEAVBITER

- ESD sikre tokomponents håndtak
- Høykvalitets stållegering
- EDGE Micro- kontrollert egg-forskyvning på mindre enn 0,2 mm
- Perfekt for urmakere, gullsmeder, finmekanikk etc



1.581,-
eks mva



261,-
eks mva



Art kode
6151

PRESISJONSSIDEAVBITER

- ESD sikre tokomponents håndtak
- Høykvalitets stållegering
- Klippekapasitet hard tråd 0,1 mm til 0,2 mm

Art kode
7154TC



261,-
eks mva



SIDEAVBITER, AVSMALENDE HODE

- ESD sikre tokomponents håndtak
- Høykvalitets stållegering
- EDGE Flush- kontrollert egg-forskyvning på mindre enn 0,2 mm
- Perfekt for urmakere, gullsmeder, finmekanikk etc

Art kode
6152

RUSTFRITT STÅL

392,-
eks mva



SIDEAVBITER I RUSTFRITT STÅL

- ESD sikre tokomponents håndtak
- Av rustfritt stål
- EDGE Flush- kontrollert egg-forskyvning på mindre enn 0,2 mm
- Perfekt legemiddelindustrien, renrom fiskeindustrien osv

Art kode
6152SS



261,-
eks mva



SIDEAVBITER SPISST HODE

- ESD sikre tokomponents håndtak
- EDGE Flush- kontrollert egg-forskyvning på mindre enn 0,2 mm
- Perfekt for finmekanikk, industri-elektriker, elektroingeniører osv

Art kode
6159

PINSETT SETT

- Inneholder 5 pinsetter
- TL SS-SA-SL, TL AA-SA-SL, TL 2A-SA-SL, TL 4-SA-SL, TL 7A-SA-SL
- Pinsettene har perfekt balanse, spisslinjering og symmetri

Art kode
9855

1.319,-
eks mva





BAHCO



EKSTRA KRAFTIG KJEDERØRTANG

- For generell bruk på metallrør
- Selvlåsende funksjon i begge retninger
- Dobbelttsidig tannsystem for skrallelignende bruk

Art kode	Lengde	Pris
372-4	925 mm 4"	2.290,-
372-6	1110 mm 6"	4.679,-
372-8	1200 mm 8"	6.499,-



UNIVERSAL ALUMINIUMSRØRTANG

- Enhånds
- Rustbehanflet hoveddel
- Selvklemmende for enkel bruk



RØRKUTTER

- For kobber, aluminium, kobber-sink-legering, stål og rustfritt stål
- Kuttehjul montert på en tapp med kule for enkel utskifting
- Støttehjulene er belagt for å unngå forurensning på røre



Art kode	Lengde	Pris
401-16	3-16mm	228,-
401-28	3-28mm	241,-

Art kode	Lengde	Pris
380-10	253 mm 10"	445,-
380-14	320 mm 14"	595,-
380-18	455 mm 18"	775,-
380-24	607 mm 24"	1.245,-
380-36	910 mm 36"	2.435,-
380-48	1210 mm 48"	4.009,-



RØRKUTTER QUICK ADJUST

- 12-76 mm
- For kobber, aluminium, kobber-sink-legering, stål og rustfritt stål
- Rullelagre for en jevn bevegelse av kuttehjulet
- Quick adjust system



931,-
eks mva



Art kode
402-76

RØRKUTTER

- 3-35 mm
- For kobber, aluminium, kobber-sink-legering, stål og rustfritt stål
- Rullelagre for en jevn bevegelse av kuttehjulet



444,-
eks mva



Art kode
402-35



ALUMINIUMAVGRADER

- Til avgrading av rør i kobber, stål og rustfritt stål
- Avgrader både innvendig og utvendig
- Hoveddel i aluminium

Art kode	Pris
318-38	563,-
318-54	898,-



RØRBØYER

- Rørbøyer for 12,14,15,16,18 og 22 mm
- Ergonomisk design for optimal komfort og økt produktivitet
- kobber-sink-legering, stål og rustfritt stål
- Bøying av stål- og kobberør med høy presisjon. Også egnet for krom.

Art kode	Ø	Pris
500-12	12 mm	1.019,-
500-14	14 mm	1.245,-
500-15	15 mm	1.245,-
500-16	16 mm	1.245,-
500-18	18 mm	1.582,-
500-22	22 mm	1.815,-



971,-
eks mva



RØRSAKS

- For plastrør med flere lag
- Gummigrep
- Låses med en hånd

Art kode
412-26-MULTI



635,-
eks mva

SEKSKANT HYLSESKRUTREKKERSETT
• 6 deler
• To komponents T håndtak
• 5, 6, 7, 8, 10, 13 mm

Art kode
903T-3

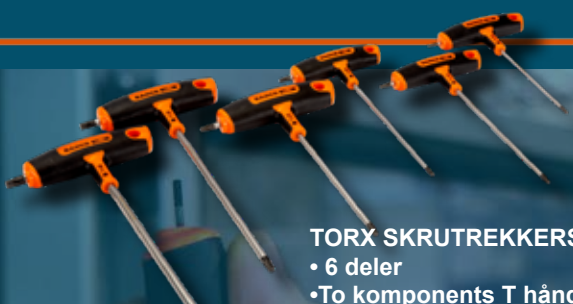

515,-
eks mva

TORX SKRUTREKKERSETT
• 6 deler
• To komponents T håndtak
• T10, T15, T20, T25, T30, T40

Art kode
903T-2



556,-
eks mva

SEKSKANT SKRUTREKKERSETT
• 6 deler
• To komponents T håndtak
• 3, 4, 5, 6, 8, 10 mm

Art kode
903T-1



297,-
eks mva



1/4" SKRALLESKRUTREKKER M/PISTOLGREP
• Bitsholder med 6 stk 1/4" bits PH 1, PH 2, PZ 1, PZ 2, spor 4,5 og 5,5
• Håndtaket er svingbart og låses i 30 graders stilling for arbeid som krever et høyere moment
• Magnetisk bitsholder

Art kode
808050P



1/4" SKRALLESKRUTREKKER M/LED LYS
• Bitsholder med 6 stk 1/4" bits PH 1, PH 2, PZ 1, PZ 2, spor 4,5 og 5,5
• 3 batterier og 2 lys
• Magnetisk bitsholder

297,-
eks mva



Art kode
808050L



165,-
eks mva

1/4" KORT SKRALLESKRUTREKKER
• Jevn skrallebevegelse med tre posisjoner: høyre, venstre og nøytral
• Tre-komponents håndtak med høy friksjon
• Magnetisk bitsholder

Art kode
808050S



185,-
eks mva



1/4" KORT SKRALLESKRUTREKKER
• Jevn skrallebevegelse med tre posisjoner: høyre, venstre og nøytral
• Tre-komponents T- håndtak
• Magnetisk bitsholder

Art kode
808050TS



BAHCO



1.353,-
eks mva



Art kode
706-5

SETT MED 24 PRESISJONSSKRUTREKKERE

- 24 stk med roterende hode
- For spor/Phillips/Pozidriv/TORX/sekskantskruer
- Spesialkonstruert for presisjonsarbeid, spesielt for mekaniske og elektroniske bruksområder

SKRUTREKKERSETT VDE ERGO SLIM

- 5 stk
- Skrutrekkere med smal klinge (reduisert klinge diameter), for spor- og Phillips-skruer
- Klingene er 30 % smalere enn vanlige isolerte klinger for bedre tilgang

**For arbeid på strømførende utstyr opptil 1000 V
Ekstra smal klinge**



249,-
eks mva

Art kode
BE-9881SL



**For arbeid på strømførende utstyr opptil 1000 V
Ekstra smal klinge**



249,-
eks mva



Art kode
BE-9882SL

SKRUTREKKERSETT VDE ERGO SLIM

- 5 stk
- Skrutrekkere med smal klinge (reduisert klinge diameter), for spor- og Pozidriv-skruer
- Klingene er 30 % smalere enn vanlige isolerte klinger for bedre tilgang



249,-
eks mva

Art kode
BE-9886



SKRUTREKKERSETT ERGO

- 6 stk
- For spor/Phillips/Pozidriv-skruer
- Enkelt å velge rett spiss med fargekodet skaft og permanent symbol på enden



249,-
eks mva



SKRUTREKKERSETT ERGO

- 8stk
- For Spor/Phillips/Pozidriv/TORX®
- Enkelt å velge rett spiss med fargekodet skaft og permanent symbol på enden



SKRUTREKKERSETT ERGO

- 5 stk
- For Torx skruer
- Enkelt å velge rett spiss med fargekodet skaft og permanent symbol på enden

Art kode
BE-9885

Art kode
BE-9872

279,-
eks mva





1/4" BITSSETT

- 54 Deler
- For spor/Phillips/Pozidriv/sekskant/TORX®/TORX® med senterhull og Robertson-skruer
- Svingbare fester.
- Patentert eske med 180° låsefunksjon. Esken forblir åpen selv om den snus opp ned uten å lukke seg mot fingrene

294,-
eks mva

Art kode
59S/54C-1

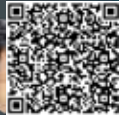

1/4" KRAFT BITSSETT

- 54 Deler
- For spor/Phillips/Pozidriv/sekskant/TORX®/TORX® med senterhull og Robertson-skruer
- Svingbare fester.
- Patentert eske med 180° låsefunksjon. Esken forblir åpen selv om den snus opp ned uten å lukke seg mot fingrene
- Torsjonssone som forlenger levetiden

448,-
eks mva

Art kode
66IM/54C-1



CARBIDE HULLSAGSETT

- 20 Deler, 16-114 mm
- For rustfritt stål, støpejern, tre med spiker, fliser, sementplater, glassfiber etc
- Ekstremt varmebestandig
- Skjæredybde maks 38 mm

3.648,-
eks mva

Art kode
3832-SET-164-ES



2.168,-
eks mva

HULLSAGSETT BLANDET

- 18 Deler, 12-86 mm
- Sandflex® hullsager i bi-metall er spesialkonstruert for skjæring i metall, men kan brukes på de fleste materialer, for eksempel tre og plast
- Flatbor for tre, gipsplater og plast
- Skjæredybde maks 38 mm

Art kode
3835-SET-711

71 mm skjæredybde!

SUPERIOR HULLSAGSETT

- 14 Deler, 19-86 mm
- For tre, tegl, MDF, gips, finer, plast etc
- 71 mm skjæredybde

Art kode
3833-SET-201



SANDFLEX® HULLSAGSETT

- 18 Deler, 16-83 mm
- Sandflex® hullsager i bi-metall er spesialkonstruert for skjæring i metall, men kan brukes på de fleste materialer, for eksempel tre og plast
- 38 mm skjæredybde

Art kode
3834-SET-152



2.585,-
eks mva





BAHCO

BAJONETTSAGBLADSETT FOR METALL

- 12 forskjellige blader hovedsakelig for metall, men også 3 blader for tre

Art kode
3940-METAL-SET-12P



537,-
eks mva



424,-
eks mva



BAJONETTSAGBLADSETT FOR TRE & METALL

- 12 forskjellige blader for metall, tre & metall, gips, gipsplater, tre og plast

Art kode
3940-MIX-SET-12P



BAJONETTSAGBLADSETT FOR TRE

- 5 Blader for tre, 4 blader i HCS for tre og plastmaterialer, 1 blad for tre med spiker

Art kode
3940-WOOD-SET-12P



601,-
eks mva

STIKKSAGBLADSETT

- 10 blader perfekte for de fleste typer metallkappejobber

Art kode
91-METAL-10P



141,-
eks mva



STIKKSAGBLADSETT

- 10 blader perfekte for alle typer kapping av tre og plast

Art kode
91-WOOD-10P



120,-
eks mva



BAJONETTSAGBLAD MED HÅRDMETALLBESTYKKEDE TENNER

- For murstein, LECA og lettbetong
- Egnet for materialtykkelser opptil 370 mm
- Passer alle typer bajonettsager

Art kode
3946-457-2-CB-1P



204,-
eks mva





BE SHARP,
USE BAHCO BANDSAWS

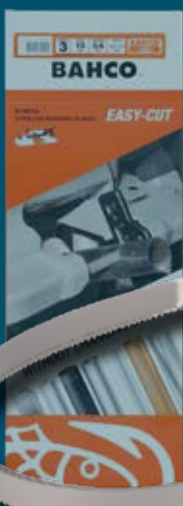

3857- 1 blad kapper alt!
Eks jern, massive materialer, rør, profil eller bunt



- BÅNDSAGBLAD FOR PORTABAND-MASKINER**
- Med unik innovativ tannprofil for generell saging
 - Bahcos unike patenterte tanngemetri gir et robust, slitesterkt og allsidig Easy-Cut blad
 - Dette bladet kutter et bredt utvalg av materialer og former, bare velg et blad som passer til størrelsen på arbeidsstykket.
 - Hver eske inneholder 3 blader

Art kode	Pris
3857-13-0.6-EZ-S-3P1140	390,-
3857-13-0.6-EZ-S-3P690	225,-
3857-13-0.6-EZ-S-3P730	294,-
3857-13-0.6-EZ-S-3P835	249,-
3857-13-0.6-EZ-S-3P900	264,-

VELG RIKTIG BÅNDSAGBLAD
Analyser bruken- Hvilken maskin bruker du?
Velg produkt
Velg tanning
Velg lengde



- SIRKELSAGBLADER TIL TRE FOR GJÆRSAGER**
- Med hårdmetallspiss
 - 0° nøytral helningsvinkel
 - Bladene er laget av herdet, kaldvalset stål



Art kode	A	B	C	Pris
8501-18SW	216 mm	30 mm	48 mm	355,-
8501-216-60SW	216 mm	30 mm	60 mm	273,-

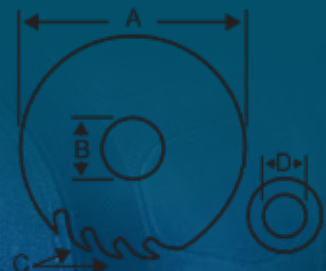



25 STK

2.675,-
eks mva



MULTIVERKTØYBLADER FOR TRE MED SPIKER

- Bi-metall med vikkede tenner for tre, gipsplater og plastmaterialer
- Ekstremt robust med starlock feste

Art kode
92-160-25P

2.915,-
eks mva

Art kode
92-225-25P

MULTIVERKTØYBLADER FOR TRE

- HCS blad med Lang smal form for dyp saging
- Egnet for alle typer tre, gipsplater og plastmaterialer
- Starlock feste



25 STK



BAHCO

MULTIVERKTØYBLADER FOR METALL

- TiN-belagt carbide bi-metallblad for krevende metallkapping
- Blad for dysaging med ekstremt god slitasjemotstand
- Starlock feste

6.535,-
eks mva

Art kode
92-236-25P

MULTIVERKTØYBLADER FOR TRE

- Bi-metallblad med vikkettanning
- Egnet for alle typer tre, gipsplater og plastmaterialer
- Starlock feste

Art kode
92-228-25P

25 STK
3.204,-
eks mva



13,-
eks mva



15,-
eks mva



43,-
eks mva



43,-
eks mva



43,-
eks mva



43,-
eks mva

KAPPEKIV

- For rustfritt stål og metall.
- 125 x 1.0 x 2.23mm

Art nr 3911-1251T41-IM

KAPPEKIV

- For alle typer aluminium
- 125 x 1.6 x 22.23mm

Art nr 3911-125-T41-AL

LAMELLSKIV

- For rustfritt stål og metall.
- 125 x P80 x 22.23mm

Art nr 3926-125IM-C80

LAMELLSKIV

- For rustfritt stål og metall.
- 125 x P40 x 2.23mm

Art nr 3926-125IM-C40

LAMELLSKIV

- For rustfritt stål og metall.
- 125 x P60 x 22.23mm

Art nr 3926-125IM-C60

LAMELLSKIV

- For rustfritt stål og metall.
- 125 x P40 x 22.23mm

Art nr 3926-125IM-C120

1.479,-
eks mva



ROTTERENDE CARBIDEFILSETT FOR ALUMINIUM

- 5 stk
- Type AL = svært grov
- For maksimal materialjerning på ikke-jernholdige materialer, f.eks aluminium og myke plastmaterialer

Art nr RB-SET-AL06-5P



HSS- G BORSETT TIL METALL

- 25 bor
- 1.0 mm til 13.0x0.5 mm
- For boring i bronse, messing, karbonstål, støpejern, leget stål og rustfritt stål

Art nr 4513-SET-25

826,-
eks mva

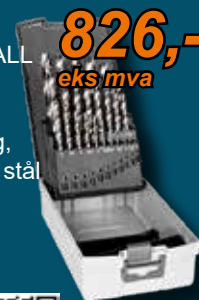

1.316,-
eks mva

HSS-E BORSETT TIL METALL

- 25 bor
- 1.0 mm til 13.0x0.5 mm
- For leget/ikke leget stål, rustfritt stål, støpejern, støpestål og syre- og varmebestandig stål

Art nr 4511-SET-25



ROTTERENDE CARBIDEFILSETT FOR METALL

- 10 stk
- Type M = Medium, dobbelthugget
- For rask materialjerning på et bredt spekter av materialer som stål, kobber, støpejern og nikkellegeringer

Art nr RB-SET-M06X-10P



2.326,-
eks mva



308,-
eks mva



HSS- R BORSETT TIL METALL

- 25 bor
- 1.0 mm til 13.0x0.5 mm
- For boring i bronse, messing, karbonstål, støpejern, leget stål og rustfritt stål

Art nr 4515-SET-25





HARD VERKTØYKOFFERT

- 23-35 L
- Kompakte mål, høy kapasitet og lett i vekt
- 1 sentrallås med nøkkel
- Koffert av sprøytetøpt polypropylen
- 2 stk låser av komposittmateriale

Art kode
4750RC01

2.071,-
eks mva



2.159,-
eks mva



HARD VERKTØYKOFFERT

- 18,5 L
- Ekstra kraftig verktøykoffert
- Korrosjons-, vann-og støvsikker
- Tåler høye og lave temperaturer:-33° til 90°
- Forsterkede hjørner for maksimal beskyttelse

Art kode
4750RCHD00



HARD VERKTØYKOFFERT

- 29 L
- Ekstra kraftig verktøykoffert
- Korrosjons-, vann-og støvsikker
- Tåler høye og lave temperaturer:-33° til 90°
- Forsterkede hjørner for maksimal beskyttelse

Art kode
4750RCHD01

2.879,-
eks mva



4.622,-
eks mva

HARD VERKTØYKOFFERT

- 29 L
- Ekstra kraftig verktøykoffert
- Korrosjons-, vann-og støvsikker
- Tåler høye og lave temperaturer:-33° til 90°
- Forsterkede hjørner for maksimal beskyttelse

Art kode
4750RCHD011

HARD VERKTØYKOFFERT M/HJUL
OG TELESKOPHÅNDTAK

- 42 L
- Koffert i polypropylen
- Korrosjons-, vann-og støvsikker
- Tåler høye og lave temperaturer:
- Med elastiske bånd i lokk og bunn

Art kode
4750RCW01

4.101,-
eks mva



HARD VERKTØYKOFFERT M/HJUL

- 31 L
- Ekstra kraftig verktøykoffert
- Korrosjons-, vann-og støvsikker
- Tåler høye og lave temperaturer:-33° til 90°
- Forsterkede hjørner for maksimal beskyttelse

Art kode
4750RCHDW01



3.471,-
eks mva



5.060,-
eks mva

HARD VERKTØYKOFFERT M/HJUL

- 53 L
- Ekstra kraftig verktøykoffert
- Korrosjons-, vann-og støvsikker
- Tåler høye og lave temperaturer:-33° til 90°
- Forsterkede hjørner for maksimal beskyttelse

Art kode
4750RCHDW02





BAHCO

KOMPLETT MOBIL LØSNING!

- 200 deler
- Heavy duty
- Robust og støtsikker koffert
- 7 innlegg med verktøy
- Kun proffverktøy
- Trillbar
- Hjul og teleskophåndtak
- Sentrallås med nøkkel
- Kan låses med TSA lås, art kode RCHD-AC1 (medfølger ikke)
- Kun 29,5 kg

**200
Deler**

16.530,-
eks mva

Art kode
BETMS120000825

**HARD VERKTØYKOFFERT
M/HJUL, SKUFFER
OG TELESKOPHÅNDTAK**

- 150 L
- Ekstra robust
- Tåler støt og røff bruk
- Fire skuffer

8.561,-
eks mva

Art kode
4750RCWD4



861,-
eks mva

- SETT MED VRIBARE HJUL**
- 4 vribare hjul istedenfor føtter
 - Gjør flyttingen enklere
 - Øker høyden med 45 mm
 - 2 hjul med brems for ekstra sikkerhet

Art kode
4750RCWD-AC1



812,-
eks mva

- VIPPBART PANEL**
- For plassering under lokk m/ lommestystem
 - Størrelse: 507 mmx 277 mm x 30 mm
 - Enkelt å montere

Art kode
4750RCWD-AC2



812,-
eks mva

- VIPPBART PANEL**
- For plassering under lokk m/ justerbare fester
 - Størrelse: 507 mmx 277 mm x 5 mm
 - Enkelt å montere

Art kode
4750RCWD-AC3

568,-
eks mva

- FAST PANEL**
- For plassering under lokk m/ justerbare fester
 - Størrelse: 490 mmx 286 mm x 4 mm
 - Enkelt å montere

Art kode
4750RCWD-AC4



BAHCO



27.500,-
eks mva

319
Deler

VERKTØYVOGN "AUTO" 26"

- 319 Deler
- 9 skuffer hvorav 8 er fylt med verktøy
- Dobbel ramme og ripesikker pulverlakk

Art kode
AUTO



341
Deler



18.437,-
eks mva

VERKTØYVOGN "LARGE" 26"

- 341 Deler
- 7 skuffer hvorav 6 er fylt med verktøy
- Dobbel ramme og ripesikker pulverlakk

Art kode
LARGE



47.250,-
eks mva

758
Deler

VERKTØYVOGN "MONSTER" 40"

- 758 Deler
- Verktøyvogn med 8 skuffer + toppskap med 4 skuffer. Verktøy i 11 skuffer
- Dobbel ramme og ripesikker pulverlakk

Art kode
MONSTER



VERKTØYVOGN "XLARGE" 26"

- 556 Deler
- Verktøyvogn med 9 skuffer + toppskap med 4 skuffer. Verktøy i 12 skuffer
- Dobbel ramme og ripesikker pulverlakk

Art kode
XLARGE



37.750,-
eks mva

556
Deler



8.125,-
eks mva

216
Deler

VERKTØYVOGN 26"

- 216 Deler
- Verktøyvogn med 6 skuffer
- Verktøy i 3 skuffer
- Dobbel ramme og ripesikker pulverlakk

Art kode
1472K6BKFF7SD



493
Deler

52.500,-
eks mva

VERKTØYVOGN 53"

- 493 Deler
- Ekstra robust Verktøyvogn med 7 skuffer. Verktøy i 5 skuffer
- Dobbel ramme og ripesikker pulverlakk

Art kode
XXL





4.485,-
eks mva



- ARBEIDSBENK I STÅL**
- 865 X 640 X 1500 MM
 - Kan sette på hjul (kjøpes separat)
 - 2 skuffer med lås
 - Ripesikker lakk

Art kode
9062-1500-1

- VERKTØYPANEL TIL ARBEIDSBENK**
- 900x 1500 mm
 - Runde standardhull 5 mm
 - Kan festes på arbeidsbenken med to festedeler (9062-FIX-1)

Art kode
9062-P1500-1

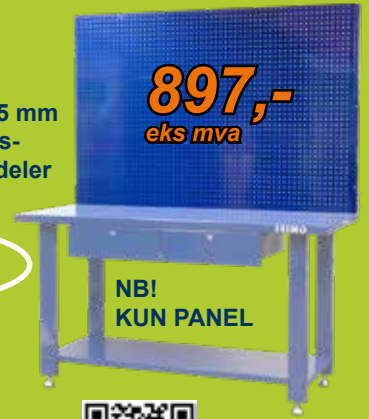

897,-
eks mva

NB!
KUN PANEL



4.805,-
eks mva

- ARBEIDSBENK I STÅL**
- 865 X 640 X 1800 MM
 - Kan sette på hjul (kjøpes separat)
 - 3 skuffer med lås
 - Ripesikker lakk

Art kode
9062-1800-1

- VERKTØYPANEL TIL ARBEIDSBENK**
- 900x 1800 mm
 - Runde standardhull 5 mm
 - Kan festes på arbeidsbenken med to festedeler (9062-FIX-1)

Art kode
9062-P1800-1



1.089,-
eks mva

NB!
KUN PANEL



416,-
eks mva

- 4 HJUL FOR ARBEIDSBENK**
- 140 X 90 MM
 - Kan konverteres til faste ben ved å flytte det røde hjulet og gummiklossen flyttes ned til det blir stødig

Art kode
9062-CAST-1

- KROKSETT TIL SKAP OG PANEL**
- 16 deler
 - Sett med tre ulike kroker for paneler med runde hull

192,-
eks mva

Art kode
9062-HOOK-1



- VERKTØYPANELADAPTER**
- Adaptere med bolter for å feste panelet på arbeidsbenk 9062

96,-
eks mva

Art kode
9062-FIX-1



- TRALLE**
- Lastekapasitet 150 eller 300 kg
 - Sammenleggbare
 - 2 faste og to vribare hjul av polypropylen
 - Glifri lasteplate

Art kode	Kg	Mål	Pris
9063HT150	150	730x470x820 mm	859,-
9063HT300	300	920x620x870 mm	1.606,-



**208
Deler**

4.990,-
eks mva

- VERTKØYVOGN**
- 208 deler
 - 7 skuffer hvorav 3 er fylt med verktøy
 - Dobbelt ramme, lastekapasitet 440 kg

Art kode
8066K7FF208BL



1.986,-
eks mva

- TRALLE**
- 2 hyller med 50 kg lastekapasitet på hver hylle
 - Ben av aluminium
 - Stor lastekapasitet
 - Hyllenes innvendige mål: 1025x432x759 mm

Art kode
9064K-02



BETMS= Bahco Ergo Tool Management System

BETMS
CONFIGURATOR

Bahco løsninger for verktøyoppbevaring Skreddersydde **BETMS** - løsninger

Skreddersøm • Egen produksjon • Produktivitet • Innovasjon • Organisering

*Vi skreddersyr løsninger for verktøyvogner
harde verktøykofferter, arbeidsbenker, skap og paneler,
verktøykasser i metall, plastkasser, samt bager i tekstil og lær.*



Vi tilbyr 3 nivåer spesialtilpasning

1. Verktøyvognkonfigurator

Design din egen løsning online



- Velg vogn
- Velg farge
- Velg arbeidstopp
- Velg verktøyinnlegg
- Velg tilbehør
- Lasermerk verktøy
- Merking i skuminnlegg



Push system



Merking i skum



Laser merking på produkt



2. Bibliotek med forskjellige ferdige løsninger

Vi har samlet et stort bibliotek med verktøyoppbevaringsløsninger som inneholder forskjellige løsninger for spesifikke bransjer, sektorer og arbeidsområder. Velg eventuelt en av disse løsningene som mal og tilpass til dine egne kriterier.

Kontakt oss:



3. Skreddersøm

Få hjelp av våre eksperter som skreddersyr din vogn fra bunnen

Kontakt oss:



Se vår brosjyre for forskjellige løsninger:



BLI VERKTØYEKSPERT MED

BAHCO ACADEMY



*Vi blir veldig glade hvis du vil
abonnere på vårt nyhetsbrev:*



*Følg Bahco Norge på
sosiale medier*

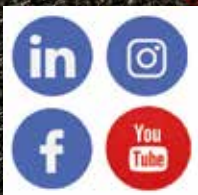

www.bahco.com